

Cabinet dimension of A12: 780mm×470mm×950mm (D×W×H), including connecting wires, air switch and wire holder. The cabinet can be mounted up to 12 pieces 65AH/12V battery or 100AH/12V battery, each layer has 4 batteries and three layers in total. The external appearance is shown as Figure 1.

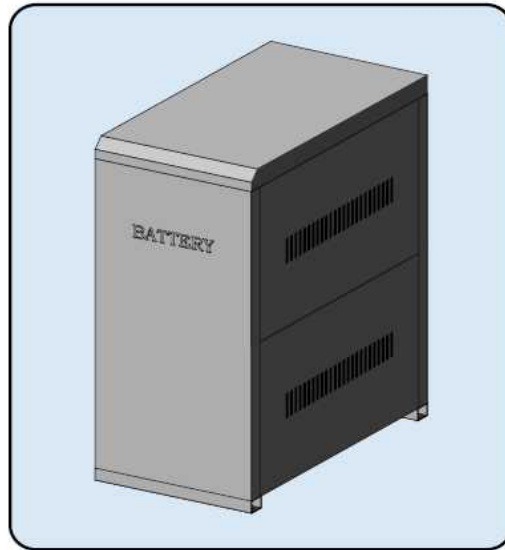

Figure 1

Installation Steps:

1. Place the cabinet base, then plug the V-slot of the front and rear panel into the flume of the base's two sides correspondingly. Shown as Figure 2.

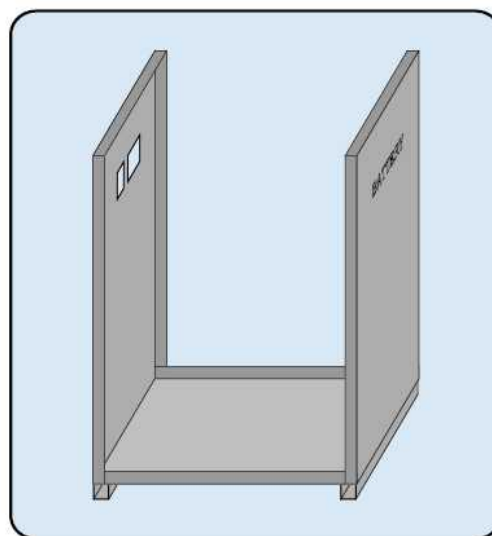

Figure 2

2. According to the accompanying wiring diagram and list, laying the batteries on the base of the battery cabinet, connecting the wires, locking the wires on **battery poles**. Shown as Figure3.

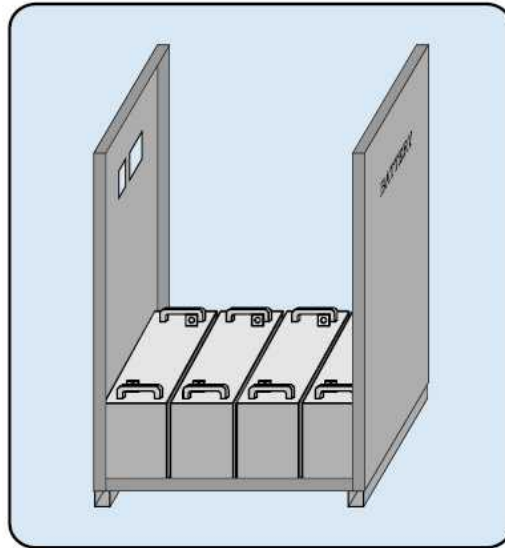

Figure 3

3. Cover the rack. According to the accompanying wiring diagram and list to install the other batteries and wires. Shown as Figure 4.

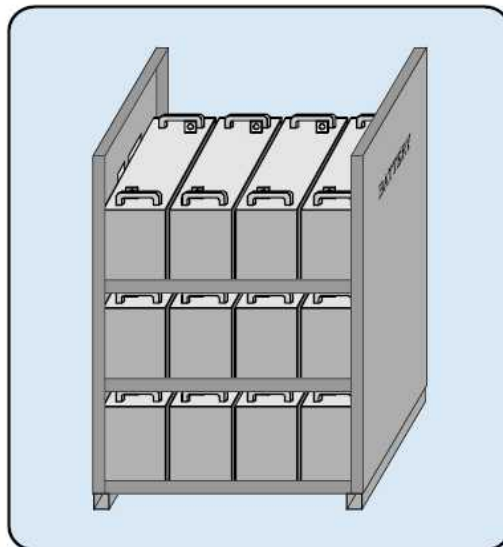

Figure 4

4. After installation is completed, checking all connections and voltage of battery are accurate. Then install right and left side panels. Shown as Figure 5.

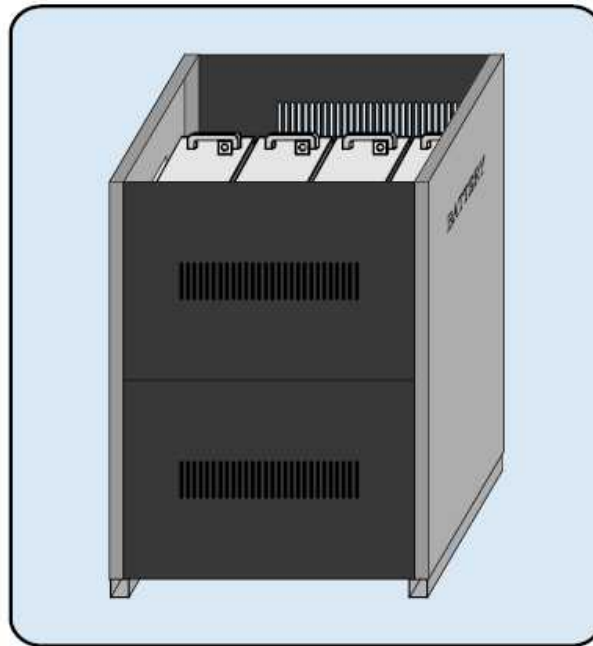

Figure 5

5. Cover the cabinet's cover. The installation of battery cabinet is completed. Shown as Figure 6.

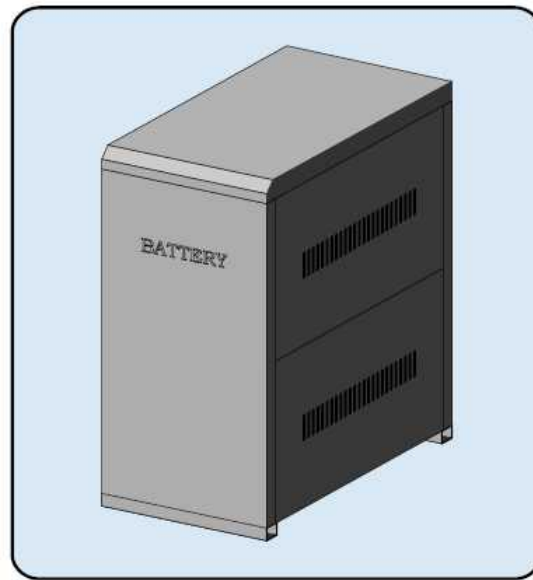

Figure 6

Wiring Method: A12 battery cabinet is placed Three groups battery. First connect the each battery group(4PCS batteries each group)in series, then connect that three battery groups in series. Connect the positive and negative of battery groups to the air switch on the rear panel, then lead out two wires from it to connect to wire holder. Shown as Figure 7.

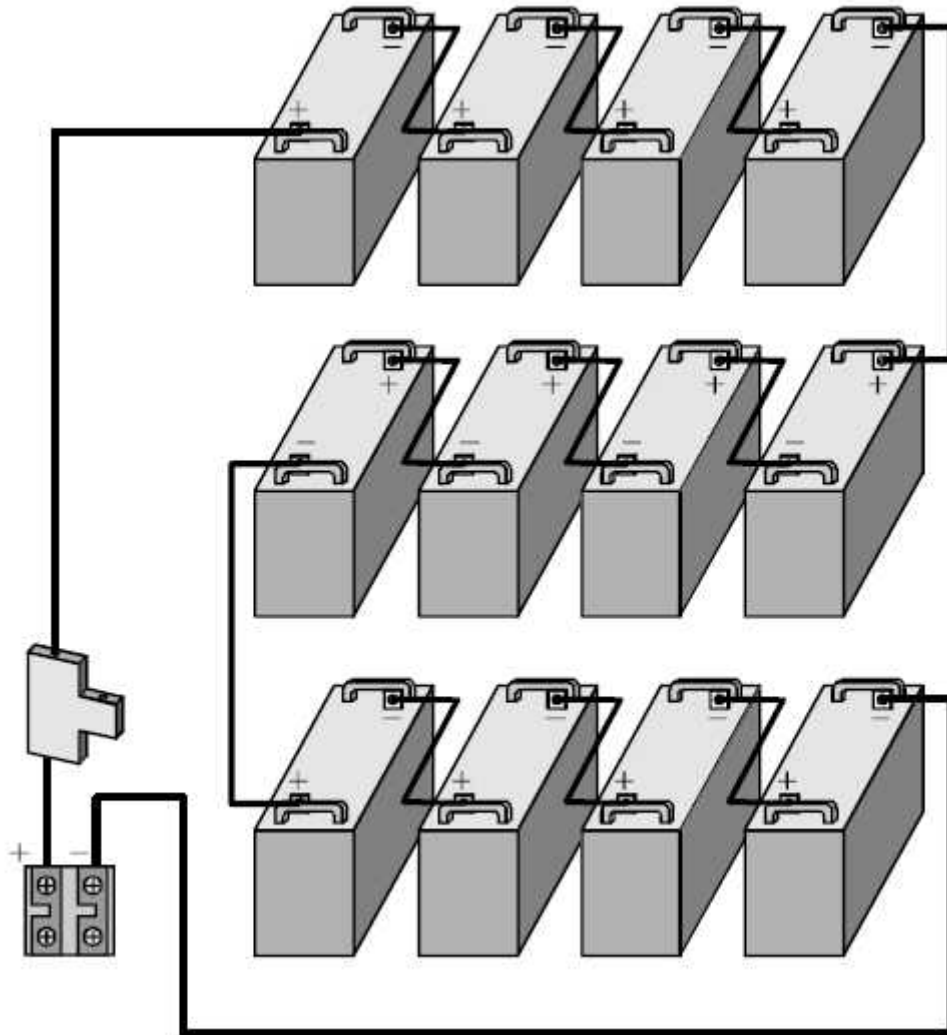

Figure 7

Notes: Don't anti-connecting the cathode and anode of the battery, or else that will do damage to the battery or cause other accidents.

A12 battery cabinet's fittings. Shown as the following:

Case parts	Quantity	Wire(6mm ²)	Quantity	Remarks
Base	1	Black 450mm	11	Double-ended OL15.5-8 terminal
Front panel	1	Black 1300mm	1	Double-ended OL15.5-8 terminal
Rear panel	1	Red 200mm	1	Single-ended OL15.5-8 terminal
Rack	2	Red 300mm	1	Single-ended OL15.5-8 terminal
Side panel	4			
Cover	1		1	
Cover of Wire holder	1			
C45 bracket black	1			
63A-1P/offwhite Air switch	1			
60A-2P black wire holder	1			
M5*25 cross pan head screw	2			
PM5*10 cross pan head screw	1			
M5T=3.8mm external hex nut	3			